

## Open Carrier Double-Balanced Mixer For Microwave Telecommunications

**MC4520**  
V1

### Features

- LO 4.0 to 20.0 Ghz
- RF 4.0 to 20.0 GHz
- IF DC to 4.0 GHz
- LO Drive +20 dBm (nominal)
- Microstrip Interface

### Description

The MC4520 is a double balanced mixer, designed for military, commercial and test equipment applications. The design utilizes Schottky ring quad diodes and broadband soft dielectric baluns to attain excellent performance. This mixer can also be used as a phase detector and/or bi-phase modulator since the IF port is DC coupled to the diodes. Environmental screening is available to MIL-STD-883, MIL-STD-202 or MIL-M-28837, consult factory.

### Product Image



### Ordering Information

Part Number	Package
MC4520	Open Carrier
MC4520-2	Open Carrier

### Electrical Specifications: $Z_0 = 50\Omega$ $Lo = +20$ dBm (Downconverter application only)

Parameter	Test Conditions	Units	Typical	Guaranteed	
				+25°C	-40° to +85°C
SSB Conversion Loss (max)	fR = 6.0 to 18.0 GHz, fL = 6.0 to 18.0 GHz, fl = DC to 2.0 GHz	dB	6.5	8.0	8.5
	fR = 6.0 to 18.0 GHz, fL = 6.0 to 18.0 GHz, fl = DC to 4.0 GHz		7.0	8.5	9.0
	fR = 4.0 to 20.0 GHz, fL = 4.0 to 20.0 GHz, fl = DC to 4.0 GHz		7.5	9.0	9.5
SSB Noise Figure (max)	Within 1 dB of conversion loss	dB	—	—	—
Isolation, L to R (min)	fL = 8.0 to 16.0 GHz	dB	35	25	23
	fL = 6.0 to 18.0 GHz		30	20	18
	fL = 4.0 to 20.0 GHz		25	12	10
Isolation, L to I (min)	fL = 8.0 to 16.0 GHz	dB	32	25	23
	fL = 6.0 to 18.0 GHz		30	20	18
	fL = 4.0 to 20.0 GHz		28	12	10
Isolation, R to I (min)	fR = 4.0 to 20.0 GHz	dB	35		
1 dB Conversion Comp.	fL = +20 dBm	dBm	+13		
Input IP3	fR1 = 8.4 GHz at -5 dBm, fR2 = 8.42 GHz at -5 dBm, fL = 8.6 GHz at +20 dBm	dBm	+20 +18		
	fR1 = 14.4 GHz at -5 dBm, fR2 = 14.42 GHz at -5 dBm, fL = 15.4 GHz at +20 dBm				

**Open Carrier Double-Balanced Mixer  
For Microwave Telecommunications**

**MC4520**  
V1

**Typical Performance Curves**

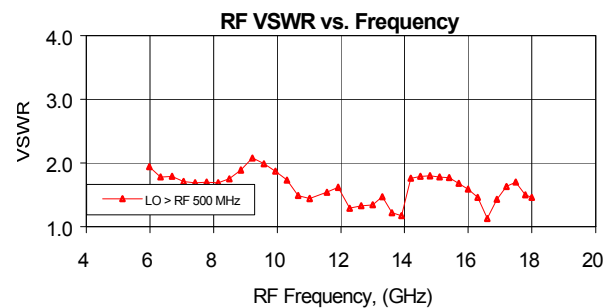
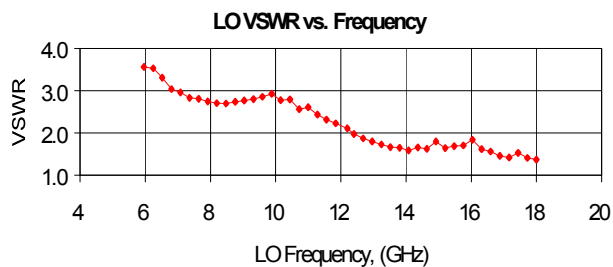
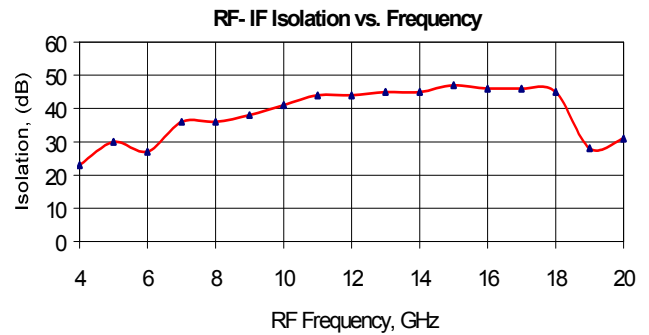
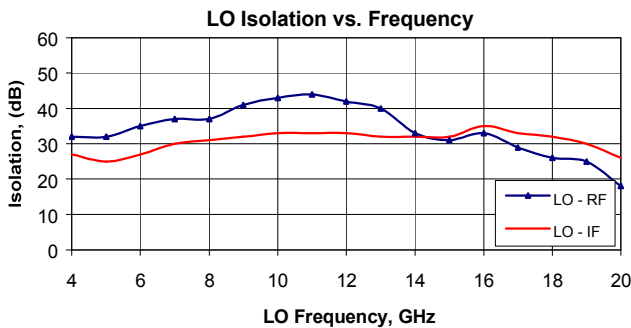
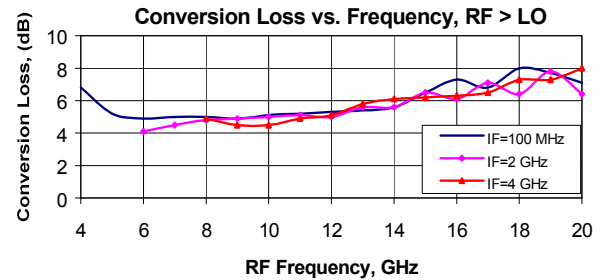
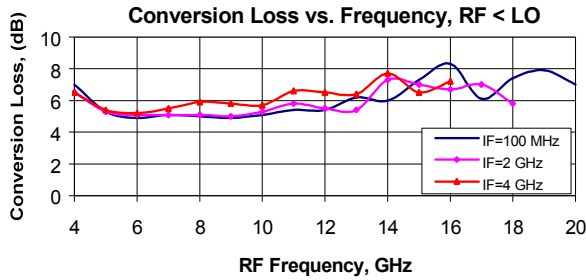

**Open Carrier Double-Balanced Mixer  
For Microwave Telecommunications**

**MC4520**  
V1

**Absolute Maximum Ratings**

Parameter	Absolute Maximum
Operating Temperature	-40°C to +85°C
Storage Temperature	-65°C to +100°C
Peak Input Power	+20 dBm max @ +25°C +17 dBm max @ +85°C
Peak Input Current	50 mA DC

**Outline Drawing: Open Carrier \* MC4520**

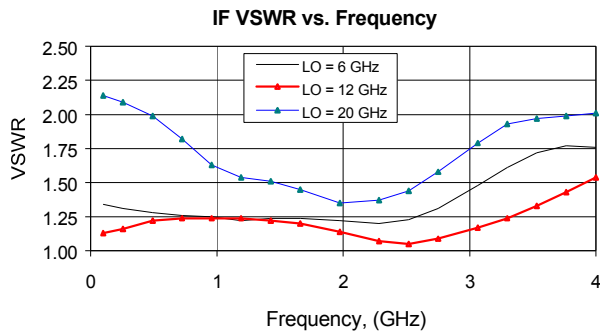
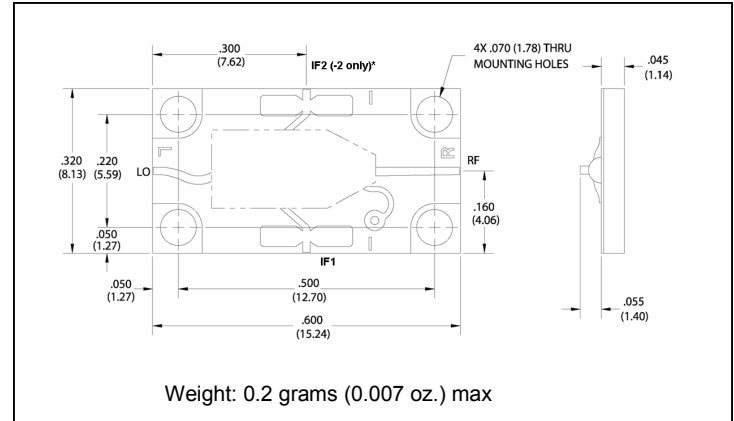

\*For the base model, only IF1 port is connected.  
For the “-2” model, only IF2 port is connected.

\* Dimensions are inches (millimeters) ±0.015 (0.38) unless otherwise specified.